

A150.

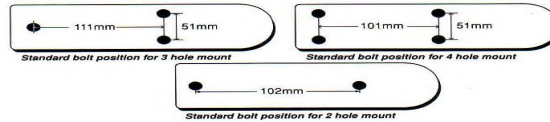

2Tonne 50mm Plunger Coupling
No adjusting screw fitted
Padlocking facility for security
Contoured handle for easy lift
2 bolt pattern standard
No hole, 3 or 4 hole by request



A155.



2Tonne 50mm Plunger Coupling
No adjusting screw fitted
Padlocking facility for security
Contoured handle for easy lift
2 bolt pattern standard
No hole, 3 or 4 hole by request

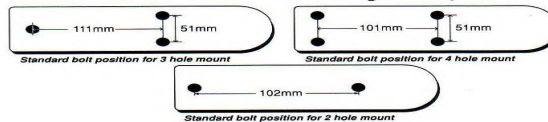

A632.



1000kg-50mm Starnut Coupling
Std 2 Bolt Pattern
65mm Hole centres

A788.



2 Tonne-50mm Weld on Coupling
Fitted with adj screw
Padlocking Facility
Suitable for welding to Drawbar.

A800. Override Coupling:

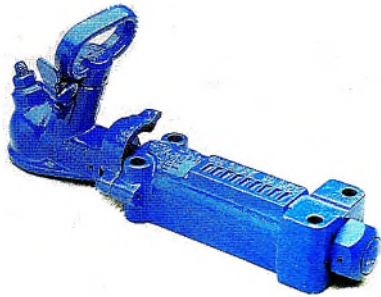

50mm Override Coupling Body
Heavy duty 38mm S1040 shaft
Domed end for constant braking
Padlocking facility for security
Grease nipples fitted for servicing
All ductile castings
Reversing lock facility

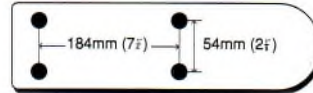

A803 Hydraulic Brake Assy.



Full Adjustment-Max Performance
Full Master cylinder travel.
Anti-swing ratchet.
Suits 3/4", 7/8", 1" cylinders
Contoured hand brake lever.

A807 Mechanical Adaptor Plate.

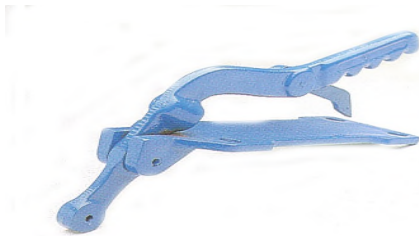

Contoured hand brake lever.
Anti-swing ratchet.
Use with A800.

MSK34 Master Cylinder.



3/4" Master Cylinder
Fits A803 Bracket Assy.

Also available in 7/8" & 1".

A900

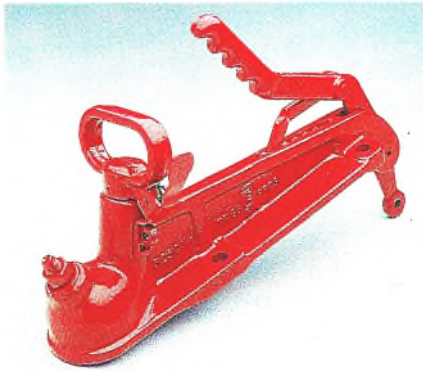

3500KG 50mm Electric Coupling
Fitted with adjusting screw
Padlocking facility for security
All Ductile Castings
Contoured hand brake lever
Anti-swing ratchet

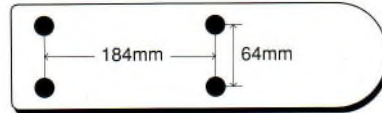

PB700/PB750 Polyblock Couplings:



**2000kg Override Polyblock Coupling-
PB700**

**3000kg Swivel Polyblock Coupling-
PB750**

Transparts Qld Pty Ltd.
Transparts WA Pty Ltd

104 Gardens Drive, Willawong Qld. 4110 Ph: 07-32734155
21 Adrian Street, Welshpool. WA 6106 Ph: 08-93611944

Part Number: A760
76mm Fixed Eye
3000kgs. Capacity

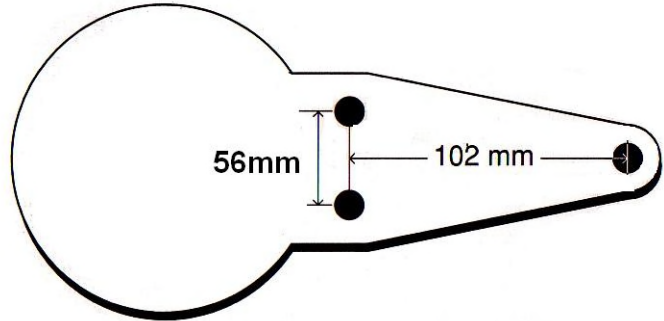

Part Number: A795TP.
76mm Fixed Eye
3500kgs. Capacity
6000kgs- Non Road Use.

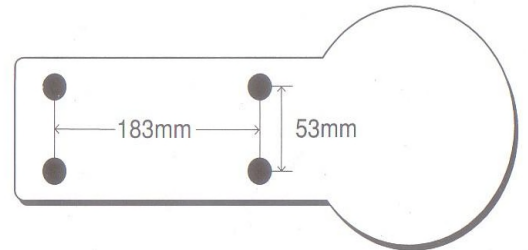

Part Number: A790.
76mm Override Coupling
2tonne Capacity.
Mtg Holes: 184 x 55 mm.



3" COUPLER-SM300

Part No: SM300.

SUITS 3" BALL WT:8.2KGS

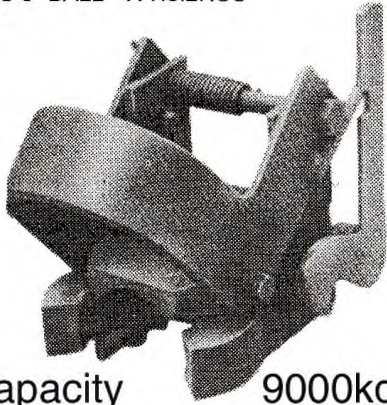

Capacity 9000kgs

2 5/16" COUPLERS-TP2516

Capacity
6000kgs



SUITS 2 5/16" BALL WT:8.2KGS

**WF60 - 6000KG CAP
 HEAVY DUTY 70mm DIA
 BALL COUPLING**

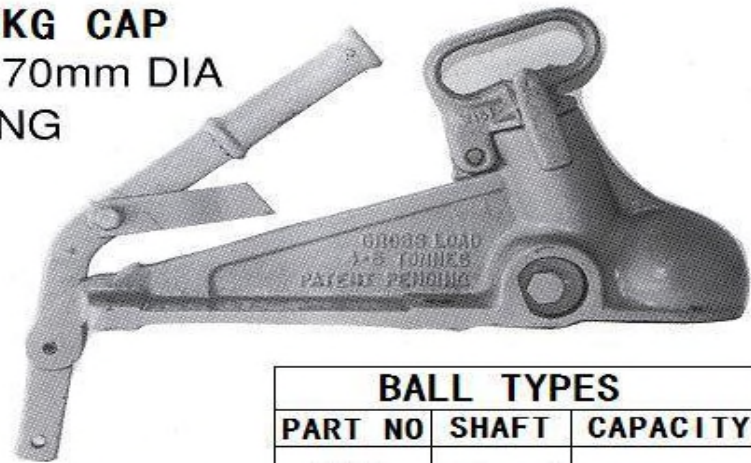

Capacity - **6000KGS**
 Features - Anti Rattle Spindle Adjustment (Patent Pending)
 Quick Release Spindle
 Heavy Duty Construction

BALL TYPES		
PART NO	SHAFT	CAPACITY
W46	42mm \varnothing	4.5t
W46TP	1-1/4" \varnothing	4.5t
W600	1-1/2" \varnothing	6t

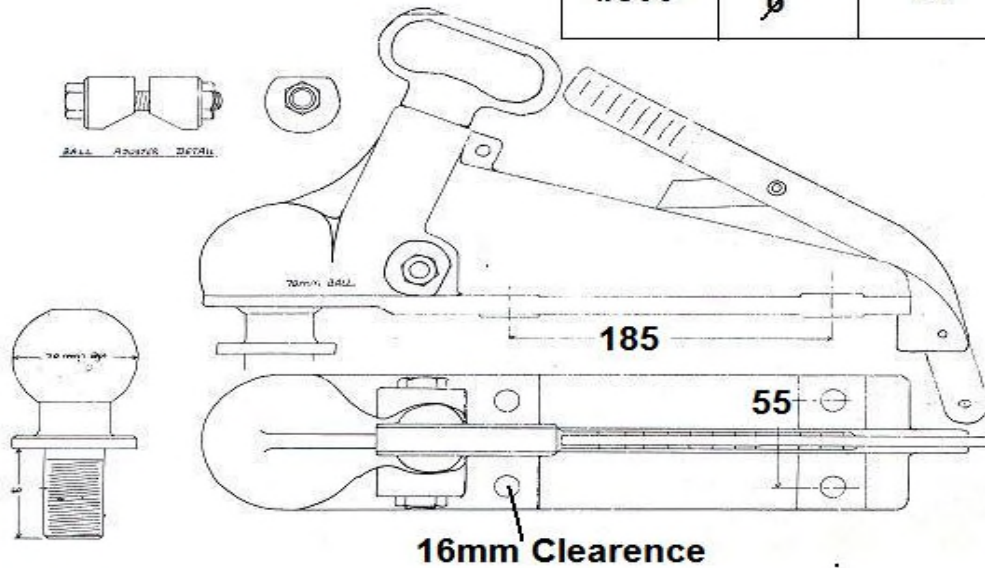

A-FRAME COUPLERS 50 DEG.



CATALOG #	BALL SIZE	WT. EA.	MAX. CAPACITY	
2405179	2-5/16"	9	25,000	May be welded

ADJUSTABLE COUPLERS

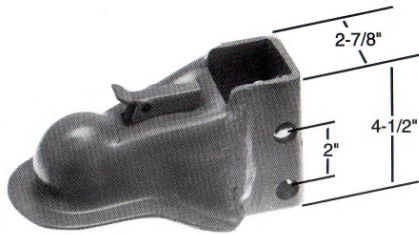

CATALOG #	BALL SIZE	RO/T SIZE	MAX. VERTICLE	GROSS TRAILER WT.	WT. EA.
2425160	2-5/16"	5/8"	1,200	12,000	9-1/2

Model: 4B4M Part No: 028444 O/All Length : 16 1/2".

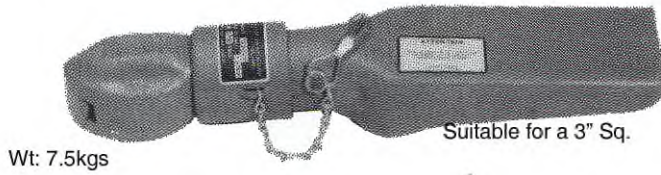

Wt: 7.5kgs

Suitable for a 3" Sq.

Model 4B2M Part No: 028442 12,500lbs.



Wt: 7.3kgs

2 1/4 OD x 1 3/4 ID
 Steel Tubing

Model:4B8L Part No: 028499 12,500lbs. O/all Length 16 1/2".

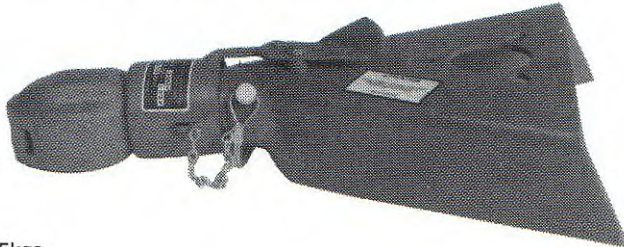

Wt: 7.5kgs

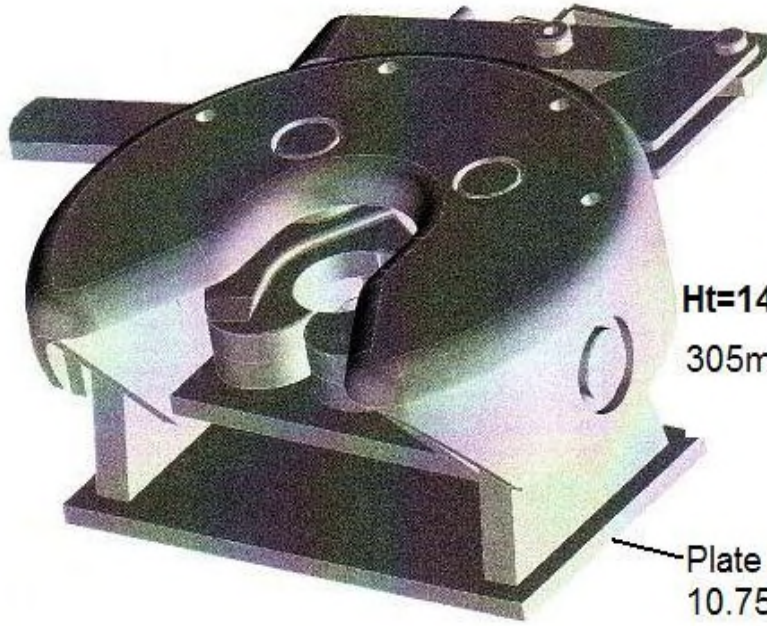

BFW0001

Capacity: 40 kN

3632kgs Max.Vert Load

14,528kgs Max. Drawbar Pull

Ht=140mm (5.5")

305mm (12") Dia

Plate Size:
10.75" x 6" (170 x 150)

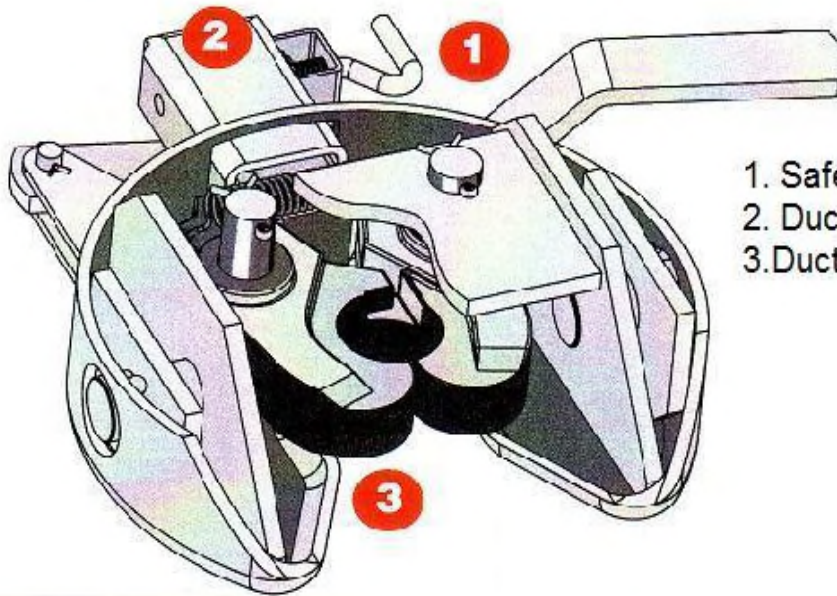

1. Safety Lock handle
2. Ductile Iron Locking Block
3. Ductile Iron Cast Split Locks

BFW0030 Demountable Kingpin

